

Powerwerx DB-750X

VHF/UHF



**Dual Band Commercial Radio
User's Manual**

Powerwerx offers the best in Land Mobile Commercial Communications, featuring rugged mobiles and handhelds at affordable prices. For additional information visit our web site: www.powerwerx.com



NOTE

This commercial mobile radio ships from the manufacturer “Display Locked” per FCC rules. You must have the RPS-DB750X-USB programming kit to unlock this radio for the first time of use. If you do not want to purchase this optional software, your radio dealer must first unlock this radio before regular use.

When programming this radio for the first time with the optional PC Programming kit, it is recommended you first READ the radio with software and then save this file for future reference. In addition, after you READ this radio with software, first make your programming and frequency changes, then send this edited file back to your mobile radio. Please contact the dealer you purchased this radio from or Powerwerx should you have any questions.

Thank you for choosing this Powerwerx DB-750X Dual-Band Land Mobile transceiver. This dual-band mobile is built to rugged commercial radio standards and features 50 Watts power output on VHF and 40 Watts output on UHF, seven character alphanumeric display, AM “Air Band” receive, and direct-flow heavy duty heat sink with thermostatically-controlled cooling fan designed for years of trouble free operation.

The DB-750X dual-band radio offers four true dual receive modes: (V+U, V+V, U+U and U+V). For simple operation this radio also features single display mode to monitor one channel at a time. The DB-750X includes 750 memory channels, 10 memory banks, full duplex operation, separate volume and squelch controls, built-in CTCSS/DCS, DTMF signaling and optional detachable remote front panel for flexible installation. This dual-band radio is offered as a mobile or can be configured as a base station using the optional SS-30DV Power Supply and MBXCOVR Radio Enclosure.

This mobile transceiver includes a variety of features so we recommend that you review this manual prior to using this radio.

Caution

Please observe the following precautions to prevent fire, personal injury, or transceiver damage:

- ⚠ Do not attempt to program your radio while driving.
- ⚠ Do not place this transceiver in a dusty, humid or wet area.
- ⚠ Do not expose this transceiver to long periods of direct sunlight.
- ⚠ Do not mount this transceiver or remote control head near vehicle heating vents.
- ⚠ Do not transmit in the high power mode for extended periods of time as it may overheat the radio. For longer transmit key downs, it is recommended you use the “MID1” or “MID2” medium power level settings.

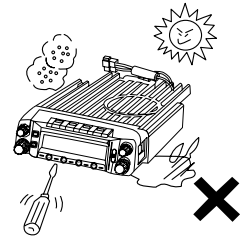

CONTENTS

New and Innovative Features	1	High/Mid/Low Power Switch	13
Frequency Range	1	Frequency Reverse.....	13
Supplied Accessories/Optional Accessories	2	Bandwidth Selection	13
Supplied Accessories	2	Home Channel	13
Optional Accessories	2	Hyper Memory Channel	13
Initial Installation	3	Dual Watch.....	14
Mobile Installation	3	Emergency Alarm.....	14
DC Power Cable Connection	4	Memory Channel/Frequency Scan	14
Antenna Connection	6	Memory Channel Scan Skip	14
Accessories Connections.....	7	Memory Channel Add	14
Getting Acquainted	8	Scan Range Limit	14
Front Panel	8	Memory Channel Copy	14
Rear Panel.....	9	Memory Channel Delete	15
Display	9	General Setting	16
Microphone	10	APO (Automatic Power Off)	16
Basic Operations	11	Automatic Offset	16
Switching the Power On/Off	11	Frequency Channel Step Setup.....	16
Adjusting the Volume	11	VFO Band Lockout.....	17
Switch Between VFO and Channel Mode.....	11	Beep Function.....	17
Adjusting Frequency	11	CPU Clock Frequency Change.....	17
Adjusting Channel.....	11	2-Tone Encode Select.....	17
Switch Between Main Band and Sub Band	12	5-Tone Encode Select.....	18
Selecting the Frequency Band.....	12	Additional Signaling Feature	18
Receiving	12	CTCSS Encode Setup	18
Squelch Off/Squelch Off Momentary.....	12	CTCSS Decode Setup	19
Transmitting	12	Sub Band Display Setup	19
Shortcut Operations	13	DTMF Encode Pre-Loading Time	19
Squelch Level Setup	13	DTMF Encode Transmitting Time	20
Transmit DTMF / 2-Tone / 5-Tone Signaling	13	DTMF Encode Setup	20

CONTENTS

Squelch Mode Setup.....	20	AM Function.....	29
Compander.....	21	Automatic AM Function.....	29
Scrambler Setup.....	21	External Speaker Port.....	29
Tone Burst.....	21	Beep Volume Control.....	30
Keypad Mode Setup.....	22	Talk Around.....	30
Keypad Lockout.....	23	Microphone Speaker.....	30
TX OFF (PTT Lockout).....	23	Password Function.....	30
Squelch Level Setup.....	23	Microphone Operation.....	31
Frequency Reverse.....	23	Send DTMF Signaling.....	31
Sub Band Mute Setup.....	24	Main/Sub Band Switching.....	31
Editing Channel Name.....	24	Function Operation through PA-PD Keys.....	31
Channel Function Auto Storage Setup.....	24	Memory Banks.....	33
Microphone PA, PB, PC, PD Key Setup.....	25	Assigning Memory Bank to a Channel.....	33
RF Squelch Level Setup.....	25	Choosing Active Bank.....	33
Offset Direction Setup.....	25	Bank Linking.....	33
Scan Dwell Time Setup.....	25	Cable Clone.....	34
Priority Channel Scan.....	26	Reset to Factory Default.....	34
Offset Frequency Setup.....	26	Maintenance.....	35
Display Mode Setup.....	26	Default Value for Factory Resume.....	35
Busy Channel Lockout.....	27	Trouble Shooting.....	35
Radio's DTMF Self ID Enquiry.....	27	Specifications.....	36
5-Tone Self ID Enquiry.....	27	Attached Chart.....	37
TOT (Time-Out Timer).....	27	51 groups CTCSS Tone Frequency (Hz).....	37
VFO Frequency Linkage.....	28	1024 groups DCS Code.....	37
Wide/Narrow Band.....	28	Menu Quick Reference List.....	39
Cross Band Repeat.....	28		
LCD Backlight.....	28		
Keypad Backlight Brightness.....	29		
Calling Record.....	29		

DB-750X FEATURES:

- 750 Memory Channels
- 10 Memory Banks (with bank linking)
- 7 Character Alphanumeric Display
- Power Output: VHF 50 Watts, UHF 40 Watts (4 power levels available for each band)
- Dual Receive Operation (V+U, V+V, U+U, U+V) with separate volume controls
- Narrow Band (2.5 kHz) operation for Land Mobile frequencies (FCC part 90)
- Wide Band (5.0 kHz) operation for Amateur frequencies
- Dual or Single Display / Receive Modes
- Large LCD Display with adjustable Colors and Brightness
- Built-in CTCSS/DCS per channel
- PC programmable with RPS-DB750X-USB Programming Kit
- Base Station Operation w/ optional Power Supply (SS-30DV) and optional Radio Enclosure (MBXCOVR)

FREQUENCY RANGE

RX: 108~136 MHz AM

136~174 MHz FM Wide or FM Narrow

220~260 MHz FM Wide

350~490 MHz FM Wide or FM Narrow

TX: 136~143.995 MHz FM Narrow

144~147.995 MHz FM Wide

148.000~174 MHz FM Narrow

400~429.995 MHz FM Narrow

430~449.995 MHz FM Wide

450~469.995 MHz FM Narrow

470~490 MHz FM Wide

SUPPLIED ACCESSORIES

After carefully unpacking the transceiver, identify the items listed in the table below. We suggest you keep the box and packaging.

- Transceiver
- Microphone with DTMF Keypad (MBXDTMF)
- Mobile Mounting Bracket (MBXBRKT)
- DC Power Cable with Fuse Holder (OEM-FM-CAB)
- Hardware Kit for Bracket

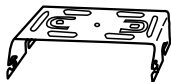
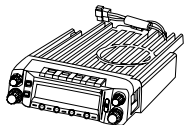

- Spare Fuses (15 A)

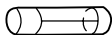

- User Manual



OPTIONAL ACCESSORIES

- Front Panel Remote Kit (MBXRMK)
- Programming Kit (RPS-DB750X-USB)
- Cigarette Lighter Plug Connection - 6 Feet (TMCG-72)
- Power supply (SS-30DV)

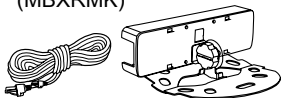

- Base Station Radio Enclosure (MBXCOVER) Includes Power Adapter (MBXRPA)

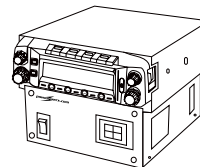

- Dual Band Mobile Mag Mount Antenna (MBXGAIN)

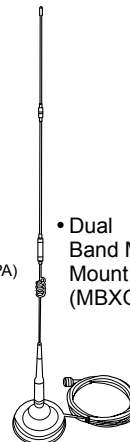

- Desktop Microphone (MBXDESK)
- External Speaker (MBXSPK)
- Y Cable (MBXYCBL)
- Power Line Filter (LF-1-OEM)
- Clone Cable (MBXCLOM)
- Power Adapter (MBXRPA)
- Plain Microphone (MBXMIC)

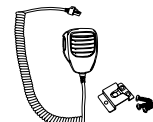
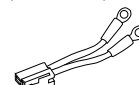
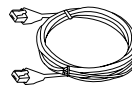
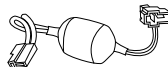
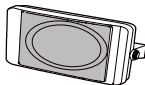
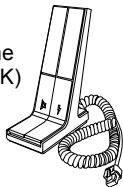

For a complete listing of current accessories see: www.powerwerx.com/mobile

MOBILE INSTALLATION

To install the transceiver, select a safe, convenient location inside your vehicle that minimizes danger to your passengers and yourself while the vehicle is in motion. Consider installing the unit at an appropriate position so that knees or legs will not strike it during sudden braking of your vehicle. Try to pick a well ventilated location that is shielded from direct sunlight.

1. Install the mounting bracket in the vehicle using the supplied self-tapping screws (4pcs) and flat washers (4pcs).

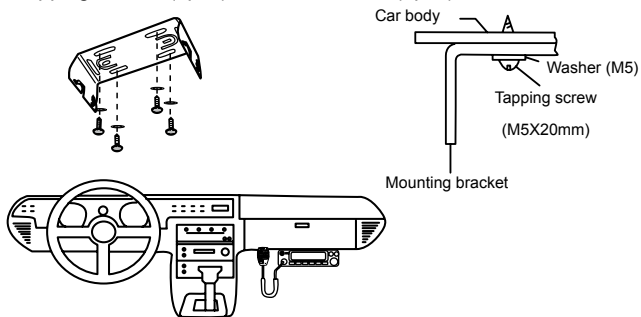

2. Position the transceiver, then insert and tighten the supplied hexagon SEMS screws.
 - Double check that all screws are tightened to prevent vehicle vibration from loosening the bracket or transceiver.

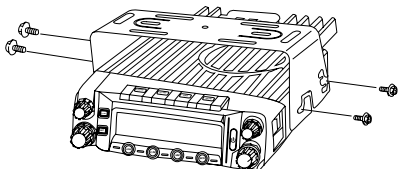

- Determine the appropriate angle of the transceiver, using the 3 screw hole positions on the side of the mounting bracket.

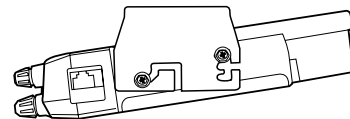
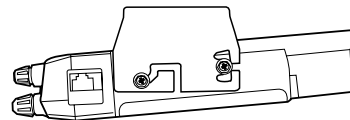
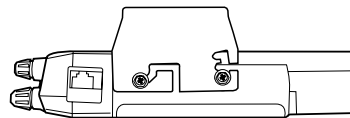

DC POWER CABLE CONNECTION



For best operation, connect directly to vehicle battery.

MOBILE OPERATION

The vehicle battery voltage must be between 11.5 ~ 14.5 Volts DC. Be sure to use a battery that has sufficient current capacity. If the current to the transceiver is insufficient, the display may darken during transmission, or transmitting output power may drop excessively.

1. Route the DC power cable supplied with the transceiver directly to the vehicle's battery terminals using the shortest path from the transceiver.
2. If using the supplied power cable make sure the entire length of the cable is dressed so it is isolated from heat, moisture, and the engine high voltage ignition system.
3. If using the optional Powerwerx TMC-72 cigarette lighter plug make sure your cigarette lighter socket in your vehicle can handle 12 VDC @ 12 Amps.



- Confirm the correct polarity of the connections, then attach the power cable to the battery terminals; red connects to the positive (+) terminal and black connects to the negative (-) terminal.



- Use the length of cable necessary to reach your battery. In particular, never remove the fuse holders from the cable.

4. Reconnect any wiring removed from the negative terminal.

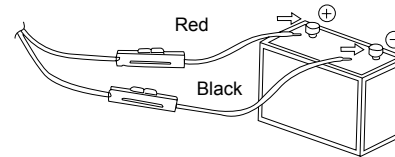

5. Connect the DC power cable to the transceiver's power supply connector.
 - Press the connectors firmly together until the locking tab clicks.

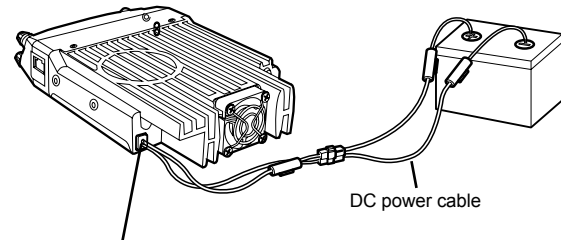

✕ BASE STATION OPERATION

In order to use this transceiver for fixed base station operation, you will need an optional SS-30DV DC power supply and optional Base Station Enclosure (not included). Please contact your local dealer for these items.

1. Connect the optional DC Power Adapter (MBXRPA) to the regulated DC Power Supply and ensure that the polarities are correct. (Red: positive, Black: negative).
2. Connect the transceiver's DC power connector to the connector on the DC Power Adapter (MBXRPA).

Press the connectors firmly together until the locking tab clicks.

- ⚠ • Do not directly connect the transceiver to an AC outlet.
- ⚠ • Use the optional DC Power Adapter (MBXRPA) to connect the transceiver to a regulated power supply.
- ⚠ • Do not substitute a cable with smaller gauge wires.

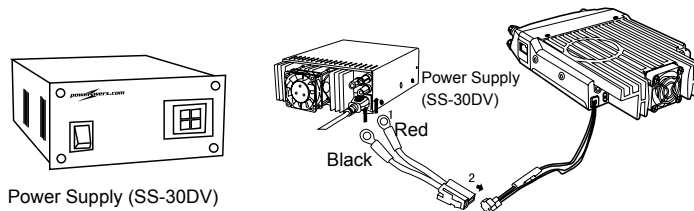

DC Power Adapter
(MBXRPA)

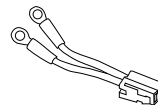

Base Station Radio
Enclosure (MBXCOVER)
Includes Power Adapter (MBXRPA)

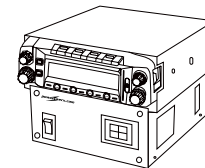

NOTE

- Before connecting the DC power to the transceiver, be sure to switch the transceiver and the DC Power Supply OFF.
- Do not plug the DC Power Supply into an AC outlet until you make all connections.

✕ REPLACING FUSES

If the fuse blows, determine the cause, then correct the problem. After the problem is resolved, replace the fuse. If newly installed fuses continue to blow, disconnect the power cable and contact your authorized dealer or an authorized service center for assistance.

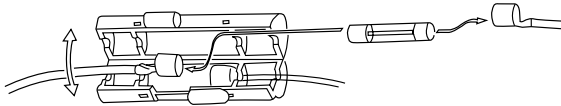

Fuse Location	Fuse Current Rating
Transceiver	15 A
Supplied accessory DC Power Cable	20 A

Only use fuses of the specified type and rating, otherwise the transceiver could be damaged.



If you use the transceiver for a long period when the vehicle battery is not fully charged, or when the engine is OFF, the battery may become discharged, and will not have sufficient reserves to start the vehicle. Avoid using the transceiver in these conditions.

■ ANTENNA CONNECTION

Before operating, install an efficient, well-tuned antenna. The success of your installation will depend largely on the type of antenna and its correct installation. The transceiver can give excellent results if the antenna system and its installation are given careful attention.

Use a 50 Ω impedance antenna and low-loss coaxial feed-line that has a characteristic impedance of 50 Ω , to match the transceiver input impedance. Coupling the antenna to the transceiver via feed-lines having

an impedance other than 50 Ω reduces the efficiency of the antenna system and can cause interference to nearby broadcast television receivers, radio receivers, and other electronic equipment.



- Transmitting without first connecting an antenna or other matched load may damage the transceiver. Always connect the antenna to the transceiver before transmitting.
- All fixed stations should be equipped with a lightning arrester to reduce the risk of fire, electric shock, and transceiver damage.

The possible locations of an antenna on a car are shown as follows:

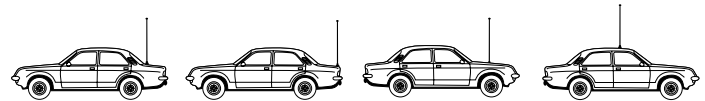

ACCESSORIES CONNECTIONS

EXTERNAL SPEAKER

If you plan to use the optional external speaker/s (MBXSPK), there are two options. For a single speaker, plug into the upper 3.5 mm SP jack on the rear of the radio to hear both bands through one speaker. To use dual speakers, use the optional Y cable (MBXYCBL) and plug it into the lower 3.5 mm ST jack on the rear of the radio to split the left and right bands between the two speakers. See page 29 for programming this function.

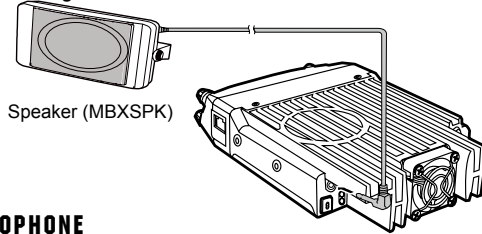

MICROPHONE

For voice communications, connect a microphone equipped with an 8-pin modular plug into the modular socket on the right side of the control head. Press firmly on the plug until the locking tab clicks. Attach the supplied microphone hanger in an appropriate location using the screws included in the screw set.

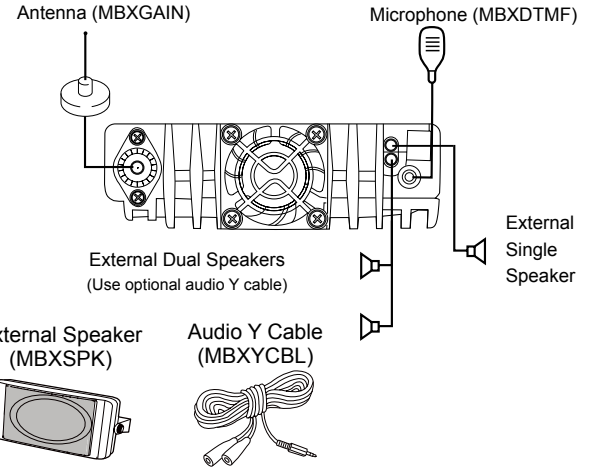
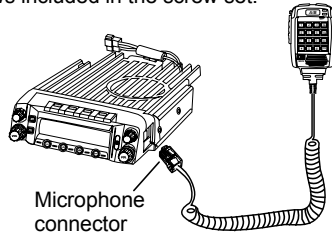

PC SOFTWARE PROGRAMMING

When programming this radio for the first time with the optional PC Programming Kit, RPS-DB750X-USB, it is recommended you first READ this radio with the software and then save the file for future reference. In addition, after you READ this radio with the software, make your programming and frequency changes, then send this program back to your mobile radio.



NOTE Ask your dealer about purchasing a Programming Kit: RPS-DB750X-USB.

FRONT PANEL

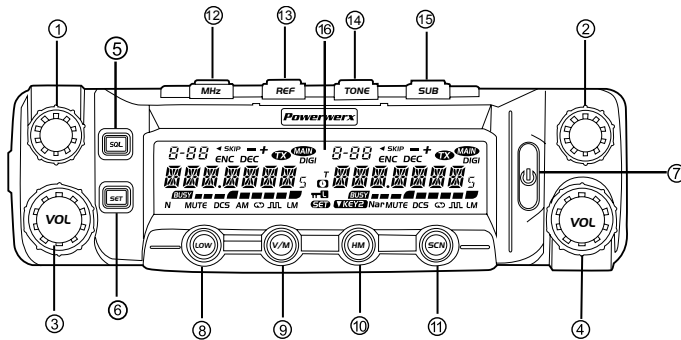

• Basic Functions

NO.	KEY	FUNCTION
1	Left Dial Knob	Rotate it to choose frequency /channel. Press it to set the left band as "Main Band"; In VFO mode, press it to choose the frequency band; In function setup as confirm key; in scan mode, rotate it to change scan direction
2	Right Dial Knob	Rotate it to choose frequency /channel. Press it to set the right band as "Main Band"; In VFO mode, press it to choose the frequency band; In function setup as confirm key; in scan mode, rotate it to change scan direction
3	Left Volume Knob	Adjust left band volume level.
4	Right Volume Knob	Adjust right band volume level.
5	Squelch [SOL]	Press this key and hold to adjust squelch while either turning left dial knob or right dial knob

6	Function set Key [SET]	In standby, press this key to enter function menu
7	[Power On/Off]	Press it to power On /Off the transceiver
8	Bottom [LOW] Key	In standby press it to change H/L power for left band channel. Long press it to turn On/Off Frequency Reverse Function
9	Bottom [V/M] Key	In standby, press it to switch left band channel mode and VFO mode. Long press it to set Wide/Narrow band.
10	Bottom [HM] Key	In standby, press it to switch left band HOME channel and normal channel. Long press it to enter dual watch of VFO channel and current channel.
11	Bottom [SCAN] Key	In standby, press it to start left band channel or frequency scan. In channel mode, hold it to set current channel scan skip.
12	Top [LOW] Key	In standby press it to change H/L power for right band channel. Long press it to turn On/Off Frequency Reverse Function
13	Top [V/M] Key	In standby, press it to switch right band channel mode and VFO mode. Long press it to set Wide/Narrow band.
14	Top [HM] Key	In standby, press it to switch right band HOME channel and normal channel. Long press it to enter dual watch of VFO channel and current channel.
15	Top [SCAN] Key	In standby, press it to start right band channel or frequency scan. In channel mode, hold it to set current channel scan skip.
16	LCD	For channel, frequency and function display setup.

REAR PANEL

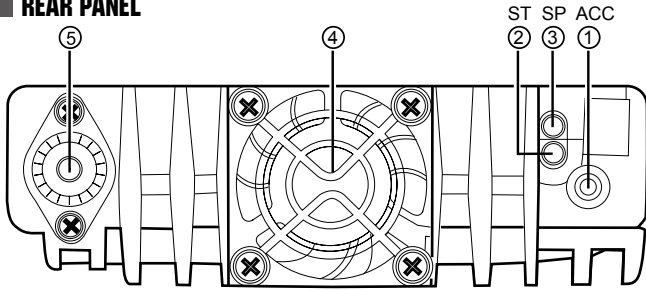

NO.	KEY	FUNCTION
1	Ext. Power Jack	Not available in US model.
2	Ext. Dual Spkr Port	Terminal for optional dual external speakers.
3	Ext. Single Spkr Port	Terminal for optional single external speaker.
4	Heat-Sink Fan	Runs Automatically when radio temperature rises.
5	Antenna Connector	Connect a 50 Ω antenna.

DISPLAY

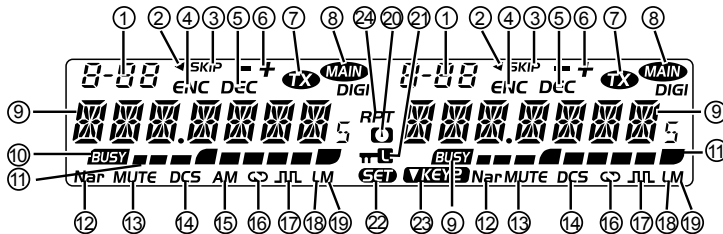

NO.	INDICATOR	FUNCTION
1	8-00	Displays the channel number and Menu number.
2	◀	Appears when current channel is priority channel.
3	SKIP	Appears when current channel is set Scan Skip.
4	ENC	Appears when current channel has CTCSS Encode.
5	DEC	Appears when current channel has CTCSS Decode.
6	- +	Appears when the Offset function is ON.
7	TX	Appears while transmitting.
8	MAIN	Displays the Main channel.
9	██████████	Displays the operating frequency, channel name.
10	BUSY	Displays when receiving a signal or Monitor is ON.
11	▬▬▬▬▬▬	Signal strength for receiving and power level for transmitting.
12	Nar	Appears while in Narrow band.
13	MUTE	Appears when mute has been turned ON.
14	DCS	Appears when the DCS function is ON.
15	AM	Appears while in AM mode.
16	↻	Appears when the Scrambler function is ON.
17	JUL	Appears when the Compander function is ON.
18	L	Appears while using Low output power.
19	M	Appears while using Middle output power.
20	⏻	Appears while Auto power off function is ON.
21	🔒	Appears when the Key Lock function is ON.
22	SET	Appears when press SET key.
23	KEY2	Appears when in KEY2 mode.
24	RPT	Appears when cross band repeat function is ON.

MICROPHONE

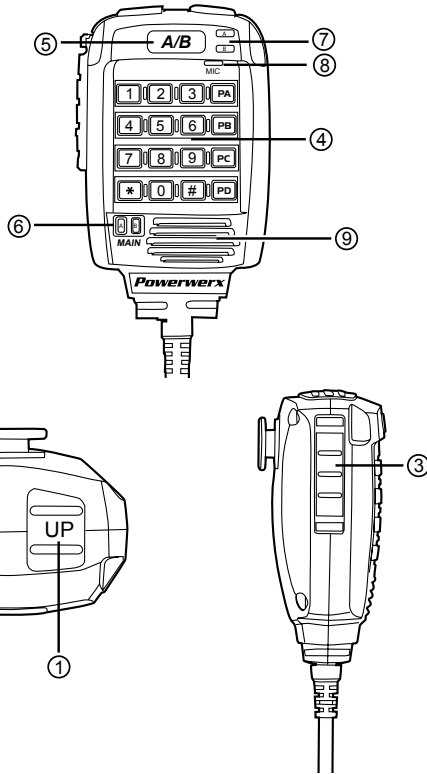

NO.	KEY	FUNCTION
1	UP	Increase frequency, channel number or setting value.
2	DOWN	Decrease frequency, channel number or setting value.
3	PTT	Press the PTT (Push-To-Talk) key to transmit.
4	Number Key	Input VFO frequency or DTMF dial out etc.
5	A/B band	Choose left band or right band as Main band
6	Band indicator	The indicator light on for Main band.
7	TX/RX indicator	Light green while receiving, Light red while transmitting.
8	MIC	Speak here during transmission.
9	Speaker	Option to hear speaker thru microphone.

MIC Connector Diagram (in the front view of connector)

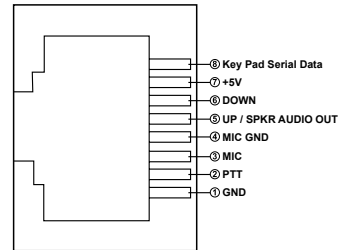

SWITCHING THE POWER ON/OFF

POWER ON

Press  key to switch the transceiver ON, the LCD displays "WELCOME DB-750X", then displays current frequency or channel.

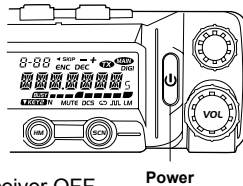

Power

POWER OFF

Press  key for 1 second to switch the transceiver OFF.

ADJUSTING THE VOLUME

Rotate the [VOLUME] knob of selected band clockwise to increase the volume, counterclockwise to decrease the volume.

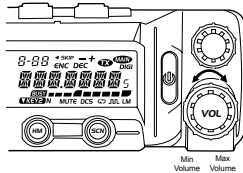

Min Volume Max Volume



To adjust the volume when no signal is present hold [50L], keep pressing it and adjust the [VOLUME] knob to desired level and release when done.

SWITCH BETWEEN VFO AND CHANNEL MODE

In standby, press corresponding  key to switch between frequency and channel mode; when the transceiver is in channel mode, the LCD will display current channel.

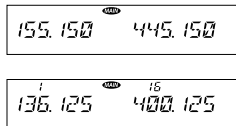

ADJUSTING FREQUENCY

ADJUSTING FREQUENCY THROUGH SELECTOR KNOB

In frequency (VFO) mode, turn the selector knob clockwise to increase frequency; counterclockwise to decrease frequency. Every click will increase or decrease frequency by one step. To adjust the Main band frequency, press corresponding selector knob, the left side of decimal point will flash. In this status, turn the selector knob to increase or decrease frequency quickly by 1 MHz steps.

Decrease frequency Increase frequency

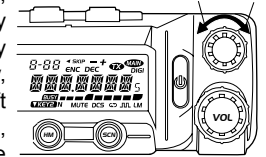

NOTE

The microphone [UP/DOWN] key is also able to adjust frequency. Pressing [UP/DOWN] key will increase(decrease) the frequency by one step size. Hold [UP/DOWN] key to adjust the frequency continuously.

INPUT FREQUENCY THROUGH MICROPHONE NUMBER KEY

In VFO mode, you can input the frequency from the microphone numeric keys. It is invalid to input frequency out of the frequency band.

For example:

to input 150.125 MHz, press 1, 5, 0, 1, 2, 5.

to input 152 MHz, press 1, 5, 2, .



NOTE

When the band lockout function is on, the input or adjusting of frequency is limited to within the current VFO band. The right band is limited to 136-174 MHz and 400-490 MHz.

ADJUSTING CHANNEL

ADJUSTING CHANNEL THROUGH SELECTOR KNOB

In channel mode, you can adjust the channel directly by the channel knob. Turn clockwise to increase one channel; turn counterclockwise to decrease one channel. To adjust the main band channel, press

corresponding selector knob. The channel number flashes in this situation; the channel number will increase 10 channels by each click of selector knob. Press microphone [UP/DOWN] key also to adjust the channel.

 If there is any empty channel, the adjustment will ignore it and jump to next channel.

❖ INPUT CHANNEL THROUGH MICROPHONE NUMBER KEY



In channel mode, you can switch to desired channel by pressing three of the microphone numeric keys (001-758). For example, input 001 for channel 1; input 030 for channel 30; input 512 for channel 512. If the input channel is not programmed with frequency, the transceiver will emit a warning beep and return to last channel.

■ SWITCH BETWEEN MAIN BAND AND SUB BAND

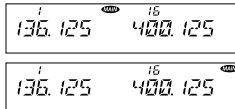
This transceiver by default shows dual receive. A "MAIN" icon will display in the top right of the working frequency. Transmitting is only available on the main band. When the left band is main band, pressing the right selector knob will switch the right band to main band. Pressing the left selector knob will switch the left band to main band.



■ SELECTING THE FREQUENCY BAND

1. Left band VFO: press the bottom  key to switch it to VFO mode, press the left selector knob over one second, then repeat above operation to switch the left band between 108~180 MHz (RX: 108-174 MHz, TX: 136-174 MHz), 220~260 MHz (RX only), 350~399.995 MHz (RX only) or 400~490 MHz.
2. Right band VFO: press the top  key to switch it to VFO mode; press the right selector knob over one second, then repeat above operation to switch the right band between 136-174MHz, 400~490MHz.



This transceiver can be set to RX/TX on 2 UHF bands or 2 VHF bands.

■ RECEIVING

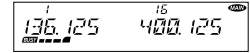

In standby, both left band and right band are able to receive. When they receive any signal, the "BUSY" icon and signal strength icon will appear in the corresponding area of the LCD, and you will hear the audio.



If the transceiver has been set at a higher squelch level, it may fail to hear the weaker stations. If the "BUSY" and signal strength icon display in left band or right band, but no station is heard, read just the squelch level to above threshold.

■ SQUELCH OFF/SQUELCH OFF MOMENTARY

Long press of  key can be programmed as Squelch Off or Squelch Off Momentary to monitor the weak signal.

1. Squelch Off: Hold  key until you hear a beep; the squelch is off. Repeat the above operation to resume squelch.
2. Squelch Off Momentary: Hold  key to disable squelch; release the key to resume squelch.



In standby, press the microphone  to cancel squelch; press it again to turn on the squelch.

■ TRANSMITTING

Hold "PTT" key; the transceiver will transmit. Hold the microphone approximately 2~5 inches from your mouth, and then speak into the microphone in your normal voice to get best results.



Transmitting is only available on the main band, the "TX" icon will display in the top right corner of the main band frequency.

SQUELCH LEVEL SETUP

This function is used to setup the level of receiving signals. When the signal strength reaches a certain level, it will unmute the transceiver.

In standby, press and hold **[SOL]** key; meanwhile turn the selector knob to adjust the squelch level of Main band.

1-20: 20 squelch levels are available.

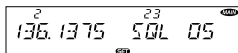

OFF: turn off squelch. The background noise will remain on.



The squelch level setup is for right band and left band separately.

TRANSMIT DTMF/2 TONE/5 TONE SIGNALING

If the current channel is programmed with DTMF / 2-Tone / 5-Tone signaling, hold PTT and **[UP]** key will transmit selected preprogrammed signaling.

HIGH/MID/LOW TRANSMIT POWER SWITCH

In standby, repeatedly press **[LOW]** key to choose power levels as follows:

When LCD displays HIGH, the power for current channel is high.

When LCD displays MID1, the power for current channel is middle 1

When LCD displays MID2, the power for current channel is middle 2.

When LCD displays LOW, the power for current channel is low.

Output power for each level:

HIGH	MID1	MID2	LOW
VHF (50 W)	VHF (20 W)	VHF (10 W)	VHF (5 W)
UHF (40 W)	UHF (25 W)	UHF (10 W)	UHF (5 W)



In channel mode, this operation is for temporary use only

FREQUENCY REVERSE

In standby, hold **[LOW]** key for one second to turn On/Off frequency reverse function. When reverse function is on, the TX frequency will change to RX frequency and RX frequency will change to TX frequency.

The signaling will also be reversed for CTCSS/DCS signaling set in this channel.



This function is valid only when current channel is programmed with repeater offset frequency and offset direction

BANDWIDTH SELECTION

This transceiver has three bandwidths. Select suitable bandwidth in accordance with different local conditions.

In standby, hold **[W/W]** key for one second to choose the three bandwidths. When LCD displays **WIDE**, current channel is working on wide band 25 kHz. When LCD displays **MIDDLE**, current channel is working on middle band 20 kHz. When LCD displays **NARROW**, current channel is working on narrow band 12.5 kHz. Per FCC Rules, in North America wide band and narrow band is used. See top of page 36 for band plan.

HOME CHANNEL

In standby, press **[H/M]** key to switch to HOME channel, and communicate on HOME channel. Repeatedly press it to return to last channel.

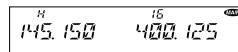

HYPER MEMORY CHANNEL

In standby, press the left or right volume knob to switch the radio to work on hyper channel 1 or hyper channel 2.

DUAL WATCH

In standby, hold **[HM]** key for one second to enter Dual Watch mode. The radio will scan the channel every 5 seconds. When the radio receives a matching signal, it pauses scanning until the signal disappears. Repeat above operation to exit dual watch.

EMERGENCY ALARM

To start emergency alarm, hold the right volume knob until the transceiver displays **ALARM** and emits an alarm. Re-power on the transceiver to exit alarm. This transceiver has four kinds of alarm which can be setup by programming software.

MEMORY CHANNEL/FREQUENCY SCAN

FREQUENCY SCAN

In VFO mode, this function is designed to monitor signals at every "step size" you have set.

1. In VFO mode, press the main band **[SCN]** key to enter channel scan.
2. During the scanning, adjust the main band selector knob or press the microphone [UP/DOWN] key to change the scan direction.
3. Press **[SCN]** key to exit scan.

MEMORY CHANNEL SCAN

1. In channel mode, press the main band **[SCN]** key to enter channel scan.
2. During the scanning, adjust the main band selector knob or press microphone [UP/DOWN] key to change the scan direction.
3. Press **[SCN]** key to exit scan.

MEMORY CHANNEL SCAN SKIP

In channel mode, switch selector knob to choose the channel, then

hold **[SCN]** for one second. The radio will beep twice and the LCD will display "SKIP"; now the current channel will be skipped during scan.

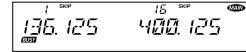

MEMORY CHANNEL ADD

1. In VFO mode, turn selector knob to select the desired frequency or input frequency by microphone numeric keypad. Set offset and CTCSS/DCS tones.

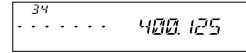

2. Hold **[SET]** key until the transceiver beeps and the channel number flashes.

3. Turn selector knob to select the channel number to store. (If the storage has data, the LCD will display the frequency, otherwise will display "-----")

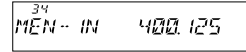

4. Press **[SET]** key. The LCD will display **MEN- IN**, and channel edit is completed.

SCAN RANGE LIMIT

You can set the VFO scan frequency range with this function:

1. Choose upper limit and lower limit frequency. Five pairs (L1 / U1 - L5 / U5) may be selected. L stands for lower the limit and U stands for the upper limit. the upper limit must be higher than the lower limit frequency. Please refer to the Channel Edit to setup the limit frequency.

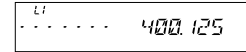

2. In VFO mode, set the VFO frequency in the range between upper and lower limit.

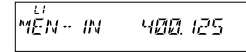

3. Press **[SCN]** key to start scan in limited range.

MEMORY CHANNEL COPY

1. In channel mode, turn the selector knob to choose the channel.
2. Hold **[SET]** key until the transceiver beeps and channel number flashes.
3. Turn selector knob to choose channel number for storage. (If the

storage has data , the LCD will display the frequency, otherwise will display"-----")

4. Press **[SET]** key. The LCD will display **MEN-IN**, and channel copy was completed.

MEMORY CHANNEL DELETE

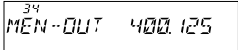
1. In standby, hold **[SET]** key until the transceiver beeps, and channel number flashes.

2. Turn selector knob to choose channel number for delete. (If the storage has data, the LCD will display the frequency, otherwise will display"-----")
3. Hold main band volume knob until the transceiver beeps twice and LCD displays **MEN-OUT**. Channel delete was completed.

Basic operation steps for function menu

1. Press **[SET]** key to enter function menu.
2. Turn the main band selector knob to choose desired function.
3. Press the main band selector knob to enter function setup.
4. Switch the main band selector knob to choose desired value.
5. Press the main band selector knob to store value and back to function menu. Press **[SQL]** key or hold selector knob for over one second to store setup and exit.

■ APO (AUTOMATIC POWER OFF)

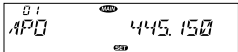
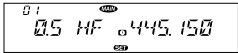
Once APO is activated, the transceiver will automatically switch off when the pre-set timer runs out.

1. Press **[SET]** key to enter function menu. 
2. Turn the main band selector knob to choose No. 01 menu. The LCD displays "APO"
3. Press the main band selector knob to enter function setup.
4. Switch the main band selector knob to choose desired value. Available values: 0.5-12 hours, OFF 
5. Press the main band selector knob or **[SET]** key to store value and return to function menu.
Press **[SQL]** key or hold selector knob for one second to store setup and exit.

■ AUTOMATIC OFFSET

When this function is on, the transceiver will automatically transmit with RX frequency ± offset frequency. The operation is as follows:

1. Press **[SET]** key to enter function menu.

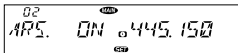

2. Turn the main band selector knob to choose No. 02 menu. The LCD displays "ARS" 
3. Press the main band selector knob to enter function setup.
4. Switch the main band selector knob to desired wanted value.
ON: Auto Offset function is turned on.
OFF: Auto Offset function is turned off. 
5. Press the Main band selector knob or **[SET]** key to store value and return to function menu.
Press **[SQL]** key or hold selector knob for 1 second to store setup and exit.



When the automatic offset is ON, the offset for 136-174 MHz is default on 0.6 MHz, and for 400-490 MHz is default on 5 MHz.

■ FREQUENCY CHANNEL STEP SETUP

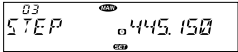
Only in frequency (VFO) mode, this function is valid. Turn selector knob to select frequency or frequency scanning which is restricted by frequency step size.

1. Press **[SET]** key to enter function menu. 
2. Turn the main band selector knob to choose No. 03 menu. the LCD displays "STEP"
3. Press the main band selector knob to enter function setup.
4. Switch the main band selector knob to choose desired value.
Available Values: 2.5 kHz, 5 kHz, 6.25 kHz, 10 kHz, 12.5 kHz, 15 kHz, 20 kHz, 25 kHz, 30 kHz, 50 kHz. 
5. Press the main band selector knob or **[SET]** key to store value and return to function menu. Press **[SQL]** key or hold selector knob for one second to store setup and exit.



NOTE This function is auto-hidden in channel mode

VFO BAND LOCKOUT

In VFO mode, when this function is on, the scanning or input of frequency will be restricted within the current VFO frequency band.

1. Press **[SET]** key to enter function menu.
2. Turn the main band selector knob to choose No. 04 menu. The LCD displays "BAND"
3. Press the main band selector knob to enter function setup.
4. Switch the main band selector knob to choose desired value.

ON: Turn on VFO band lockout function

OFF: Turn off VFO band lockout function

- 17 5. Press the main band selector knob or **[SET]** key to store value and return to function menu. Press **[SQL]** key or hold selector knob for 1 second to store setup and exit.

BEEP FUNCTION

1. Press **[SET]** key to enter function menu.
2. Turn the main band selector knob to choose No. 05 menu. The LCD displays "BEEP"
3. Press the main band selector knob to enter function setup.
4. Switch the main band selector knob to choose wanted value.

ON: Turn on Beep function.

OFF: Turn off Beep function

5. Press the main band selector knob or **[SET]** key to store value and return to function menu. Press **[SQL]** key or hold selector knob for one second to store setup and exit.

CPU CLOCK FREQUENCY CHANGE

When any harmonic or image frequency in the CPU clock disturbs the working frequency, turn on this function to cut the image channel noise.

1. Press **[SET]** key to enter function menu.
2. Turn the main band selector knob to choose No. 06 menu. The LCD displays "CLK.SFT"
3. Press the main band selector knob to enter function setup.
4. Switch the main band selector knob to choose desired value.
ON: Turn on CPU clock frequency change
OFF: Turn off CPU clock frequency change
5. Press the main band selector knob or **[SET]** key to store value and return to function menu. Press **[SQL]** key or hold selector knob for one second to store setup and exit.

2 TONE ENCODE SELECT

1. Press **[SET]** key to enter function menu.
2. Turn the main band selector knob to choose No. 07 menu. The LCD displays "2TN ENC"
3. Press the main band selector knob to enter function setup.
4. Switch the main band selector knob to choose desired value.

Available Values: 0-23, total 24 groups.



NOTE if 2-Tone encode is programmed with name, the LCD will display corresponding name.

5. Press the main band selector knob or **[SET]** key to store value and back to function menu. Press **[SQL]** key or hold selector knob for 1 second to store setup and exit.



NOTE After choosing the 2-Tone encode group, pressing PTT will transmit selected code.

5 TONE ENCODE SELECT

1. Press **[SET]** key to enter function menu.
2. Turn the main band selector knob to choose No. 08 menu. The LCD displays "5TN ENC"
3. Press the main band selector knob to enter function setup.
4. Switch the main band selector knob to choose desired value.

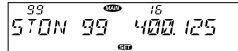
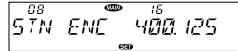

Available Values: **0-99**, total 100 groups.

NOTE If 5-Tone encode is programmed with name, the LCD will display corresponding name.

5. Press the main band selector knob or **[SET]** key to store value and return to function menu. Press **[SQL]** key or hold selector knob for 1 second to store setup and exit.

NOTE After choosing the 5-Tone encode group, pressing PTT will transmit selected code.

ADDITIONAL SIGNALING FEATURE

This transceiver has three optional signaling functions: DTMF / 5-Tone / 2-Tone. These signaling functions are similar to CTCSS/DCS signaling. When the receiver adds optional signaling, the caller shall transmit matching signaling. DTMF and 5-Tone signaling can be applied for other advanced features such as ANI, PTT ID, group call, select call, etc.

1. Press **[SET]** key to enter function menu.
2. Turn the main band selector knob to choose No. 09 menu. The LCD displays "TON DEC"
3. Press the main band selector knob to enter function setup.

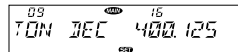

4. Switch the main band selector knob to choose desired value

DT: means DTMF signaling is added.

2T: means DTMF signaling is added.

5T: means DTMF signaling is added.

OFF: Turn off optional signaling

5. Press the main band selector knob or **[SET]** key to store value and return to function menu. Press **[SQL]** key or hold selector knob for 1 second to store setup and exit.

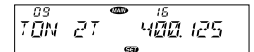

NOTE Additional signaling shall work associated with the squelch mode setup. (Refer to Squelch Mode setup on page 20)

CTCSS/DCS ENCODE SETUP

1. Press **[SET]** key to enter function menu.
2. Switch the main band selector knob to choose No. 10 menu. The LCD displays "TX CDCS"
3. Press the main band selector knob to enter function setup.
4. Switch the main band selector knob to choose desired value

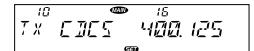

OFF: Turn off CTCSS/DCS encode.

CTCSS: Choose CTCSS encode.

DCS: Choose DCS encode.

5. Press the main band selector knob to enter the menu.
6. Switch the main band selector knob to choose desired CTCSS, DCS code.

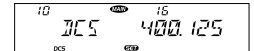
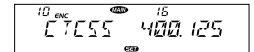

CTCSS: 62.5 - 254.1 Hz, and one self-defined group, total 52 groups

DCS: 000N-777I, total 1024 groups

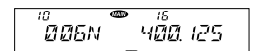
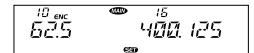

7. Press the main band selector knob or **[SET]** key to store value and return to function menu. Press **[SQL]** key or hold selector knob for one second to store setup and exit.

CTCSS/DCS DECODE SETUP

1. Press **[SET]** key to enter function menu.
2. Switch the main band selector knob to choose No. 11 menu. The LCD displays "RX CDCS"
3. Press the main band selector knob to enter function setup
4. Switch the main band selector knob to choose desired value
- OFF:** Turn off CTCSS/DCS decode.
- CTCSS:** Choose CTCSS decode.
- DCS:** Choose DCS decode.
5. Press the main band selector knob to enter the menu.
6. Switch the main band selector knob to choose desired CTCSS, DCS code.
- CTCSS:** 62.5 - 254.1 Hz, and one self-defined group, total 52 groups
- DCS:** 000N-777I, total 1024 groups
7. Press the main band selector knob or **[SET]** key to store value and return to function menu. Press **[SQL]** key or hold selector knob for 1 second to store setup and exit.

11 15
RX CDCS 400.125

11 15
CTCSS 400.125

11 15
DCS 400.125

11 15
62.5 400.125

11 15
0 10N 400.125

SUB BAND DISPLAY SETUP

1. Press **[SET]** key to enter function menu.
2. Turn the main band selector knob to choose No. 12 menu. The LCD displays "DSP SUB"
3. Press the main band selector knob to enter function setup
4. Switch the main band selector knob to choose desired value.
- FREQ:** display sub band frequency,
- DC-IN:** display sub band voltage.
- OFF:** turn off display for sub Band
5. Press the main band selector knob or **[SET]** key to store value and return to function menu. Press **[SQL]** key or hold selector knob for one second to store setup and exit.

12 15
DSP SUB 400.125

12 15
FREQ 400.125

12 15
DC-IN 13.3V

12 15
OFF

DTMF ENCODE PRE-LOADING TIME

1. Press **[SET]** key to enter function menu.
2. Turn the main band selector knob to choose No. 13 menu. The LCD displays "DTMF D"
3. Press the main band selector knob to enter function setup.
4. Switch the main band selector knob to choose desired value.
- 100MS:** The pre-loading time is 100ms
- 300MS:** The pre-loading time is 300ms
- 500MS:** The pre-loading time is 500ms
- 800MS:** The pre-loading time is 800ms
- 1000MS:** The pre-loading time is 1000ms
5. Press the main band selector knob or **[SET]** key to store value and back to function menu. Press **[SQL]** key or hold selector knob for one second to store setup and exit.

13 15
DTMF D 400.125

13 15
300MS 400.125

CTCSS/DCS decode works in conjunction with squelch mode setup. (Refer to Squelch Mode setup on page 20)

DTMF ENCODE TRANSMITTING TIME

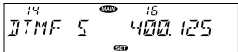
1. Press **[SET]** key to enter function menu.
2. Turn the main band selector knob to choose No. 14 menu. The LCD displays "DTMF S" 
3. Press the main band selector knob to enter function setup.
4. Switch the main band selector knob to choose desired value.
 - 30MS:** The time to transmit a single DTMF encode and the interval is 30ms,
 - 50MS:** The time to transmit a single DTMF encode and the interval is 50ms,
 - 80MS:** The time to transmit a single DTMF encode and the interval is 80ms,
 - 100MS:** The time to transmit a single DTMF encode and the interval is 100ms,
 - 150MS:** The time to transmit a single DTMF encode and the interval is 150ms,
 - 200MS:** The time to transmit a single DTMF encode and the interval is 200ms,
 - 250MS:** The time to transmit a single DTMF encode and the interval is 250ms,
5. Press the main band selector knob or **[SET]** key to store value and return to function menu. Press **[SQL]** key or hold selector knob for one second to store setup and exit.

DTMF ENCODE SETUP

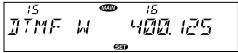
1. Press **[SET]** to enter function menu
2. Switch the main band selector knob to choose No. 15 menu. The LCD displays "DTMF W" 
3. Press the main band selector knob to enter function setup.
4. Switch the main band selector knob to choose DTMF group. Then press **[SET]** key back to DTMF menu. Press PTT to transmit with selected DTMF code.
 - 06-16:** total 16 group of DTMF code.

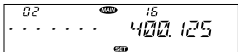

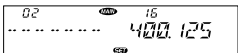
5. When the selected group is empty, the LCD displays "-----" 
6. Press the selector knob to enter the DTMF signaling edit. The LCD displays "-----", and the last character flashes.
7. Switch the selector knob to choose desired character. Press the selector knob to confirm selected value and start edit for next character.
8. Press **[SET]** key to store value and exit code editing. Press **[SET]** key again to store setup and exit. Press **[SQL]** key or hold selector knob for 1 second to store setup and exit.

SQUELCH MODE SETUP

This transceiver has five squelch modes available to prevent reception of certain unwanted signal.

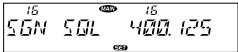
1. Press **[SET]** key to enter function menu.
2. Turn the main band selector knob to choose No. 16 menu. The LCD displays "SGN SQL" 
3. Press the main band selector knob to enter function setup.
4. Switch the main band selector knob to choose desired value
 - SQ:** Receives when carrier is detected.
 - CTSS/DCS:** Receives when carrier and CTCSS/DCS code are detected.
 - TONE:** Receives when carrier + optional signaling are detected.
 - CT*TO:** Receives when carrier + CTCSS/DCS + optional signaling are detected.
 - CT/TO:** Receives when any carrier or CTCSS/DCS or optional signaling is detected.

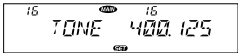

- Press the main band selector knob or **[SET]** key to store value and return to function menu. Press **[SQL]** key or hold selector knob for one second to store setup and exit.

 **NOTE** Only when the transceiver is set with CTCSS/DCS or optional DTMF / 5-Tone / 2-Tone signaling, the values will be available.

COMPANDER

Compander function will decrease the background noise and enhance audio clarity, especially in long range communication.

- Press **[SET]** key to enter function menu
- Turn the main band selector knob to choose No. 17 menu. The LCD displays "COMP"
- Press the main band selector knob to enter function setup.
- Switch the main band selector knob to choose desired function.

ON: Compander function is turned on

OFF: Compander function is turned off

- Press the main band selector knob or **[SET]** key to store value and back to function menu. Press **[SQL]** key or hold selector knob for 1 second to store setup and exit.

 **NOTE** When using compander, to avoid distortion during communications, turn on this function in all system radios.

SCRAMBLER SETUP

Scrambling offers more confidential communications. Radios on the same frequency as the scrambled radio will receive only indistinguishable noise.

- Press **[SET]** key to enter function menu.
- Turn the main band selector knob to choose No. 18 menu. The LCD displays "SCR"
- Press the main band selector knob to enter function setup.
- Switch the main band selector knob to choose wanted group

1-9 (nine fixed groups) **U1, U2** (two self defined scrambler groups), OFF.

- Press the main band selector knob or **[SET]** key to store value and back to function menu. Press **[SQL]** key or hold selector knob for one second to store setup and exit.

 **NOTE** This function should not be used on amateur frequencies, as it is illegal per FCC rules.

TONE BURST

This function is used to start a repeater. Certain repeaters require a tone burst to start when dormant. There is no need to send the tone burst again once the repeater is activated.

- Press **[SET]** key to enter function menu.
- Turn the main band selector knob to choose No. 19 menu. The LCD displays "TBST"
- Press the main band selector knob to enter function setup.
- Switch the main band selector knob to choose desired frequency.

1000: Burst frequency is 1000 Hz.

1450: Burst frequency is 1450 Hz.

1750: Burst frequency is 1750 Hz.

2100: Burst frequency is 2100 Hz.

- Press the main band selector knob or **[SET]** key to store value and return to function menu. Press **[SQL]** key or hold selector knob for 1 second to store setup and exit.

NOTE After the above setup, to activate repeater, hold microphone PTT key and **[DOWN]** key and the radio will transmit selected tone.

KEYPAD MODE SETUP

- Press **[SET]** key to enter function menu.
- Turn the main band selector knob to choose No. 20 menu. The LCD displays "KEYMOD" 
- Press the main band selector knob to enter function setup.
- Switch the main band selector knob to choose desired mode.

KEY1: Normal mode; the top four keys have same functions as the bottom four keys.

KEY2: The top four keys are shared by both bands. The bottom four keys will be re-defined.
- Press the main band selector knob or **[SET]** key to store value and return to function menu. Press **[SQL]** key or hold selector knob for 1 second to store setup and exit.

Configuration of keypad in KEY2 mode:

- Top **[V/M]** short press:** In VFO mode, short press this key; the frequency step size changes to 1 MHz. In channel mode, adjust selector knob to jump 10 channels.
- Bottom **[LOW]** long press:** In standby, long press this key to add/delete optional signaling, repeat the long press to set optional signaling to DTMF, 5-Tone or 2-Tone.

- LCD display of DT means DTMF; 5T means 5-Tone; 2T means 2-Tone.
- Bottom band **[V/M]** long press:** Talk Around. When this function is activated, transceiver does not communicate through the repeater. The transceiver will transmit on the repeater's output frequency with its CTCSS/DCS signaling. Repeat the operation to turn off Talk Around.
- Bottom **[V/M]** short press:** Frequency reverse function. When current channel is setup with offset direction and offset frequency, press this key to turn on frequency reverse function. When frequency reverse function is on, the TX frequency changes to the RX frequency and RX frequency changes to the TX frequency. The signaling will also be reversed if CTCSS/DCS signaling existed in this channel. Repeat the short press to turn off frequency reverse.
- Bottom **[V/M]** long press:** In standby, hold this key until the LCD displays **[JL]**, indicating the compander function is on. Repeat above operation to turn off compander function.
- Bottom **[HM]** short press:** In standby, press this key to set the CTCSS/DCS code for current channel.

When the LCD displays ENC, the current channel is enabled with CTCSS encode function.

When the LCD displays ENC and DEC, the current channel is enabled with CTCSS /DCS code function.

When the LCD displays DCS and DCS icon, the current channel is enabled with CTCSS code function.

When the LCD displays OFF, the current channels, CTCSS / DCS function is disabled.
- Bottom **[HM]** long press:** In standby, long press this key to enter CTCSS/DCS scan. When a matching CTCSS/DCS signal is detected, the scan will pause according to scan dwell time. The scan direction can be changed by

corresponding channel selector knob. Note: To enable this function, the channel must be programmed with CTCSS/DCS decode.

- Bottom **[SCN]** **short press**: The sub band will display "MAIN" and flashes. In this case, you can setup for sub band without switching between Main band and Sub band.
- Bottom **[SCN]** **long press**: Choose scrambler group for main band. In standby, hold this key, the LCD displays SCR X and  icon. X stands for the group number. Repeat above operation to choose desired group.

KEYPAD LOCKOUT

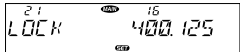
- Press **[SET]** key to enter function menu.
- Turn the main band selector knob to choose No. 21 menu. The LCD displays "LOCK" 
- Press the main band selector knob to enter function setup.
- Switch the main band selector knob to choose desired mode.

ON: The keypad lockout function is turned on. **WARNING**: All keys and functions of the radio are locked. To exit, either reprogram the radio with software or perform a hard reset. See page 34 for factory reset.

OFF: The keypad lockout function is turned off.
- Press the main band selector knob or **[SET]** key to store value and return to function menu. Press **[SQL]** key or hold selector knob for 1 second to store setup and exit.

TX OFF (PTT LOCKOUT)

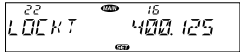
- Press **[SET]** key to enter function menu.
- Turn the main band selector knob to choose No. 22 menu. The LCD displays "LOCKT" 

- Press the main band selector knob to enter function setup.

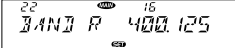
- Switch the main band selector knob to choose desired mode. 

BAND R, lock the right band PTT. Only able to transmit on left band.

BAND L, lock the left band PTT. Only able to transmit on right band.

BAND BOTH, lock both band PTT. Not able to transmit on any side.

OFF: PTT no lock.

- Press the main band selector knob or **[SET]** key to store value and return to function menu. Press **[SQL]** key or hold selector knob for 1 second to store setup and exit.

SQUELCH LEVEL SETUP

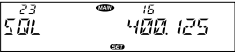
- Press **[SET]** key to enter function menu.
- Turn the main band selector knob to choose No. 23 menu. The LCD displays "SQL" 
- Press the main band selector knob to enter function setup.
- Switch the main band selector knob to choose desired value.

1-20: total 20 squelch levels.

OFF: Turn off squelch function. The background noise remains on.
- Press the main band selector knob or **[SET]** key to store value. Press **[SQL]** key or hold selector knob for one second to store setup and exit.

FREQUENCY REVERSE

With this function on, the transceiver will transmit on the repeater output when current channel is programmed with repeater offset.



- Press **[SET]** key to enter function menu.
- Turn the main band selector knob to 

choose No. 24 menu. The LCD displays "REV".

3. Press the main band selector knob to enter function setup.
4. Switch the main band selector knob to choose wanted value.



ON: Frequency reverse is turned on, The TX and RX frequency will be exchanged. The CTCSS/DCS signaling also will be exchanged if existed in current channel.

OFF: Turn off Frequency Reverse.

5. Press the main band selector knob or   key to store value and return to function menu. Press  key or hold selector knob for one second to store setup and exit.

■ SUB BAND MUTE SETUP



To avoid sub band disturbance of the main band, turn on this function. The RX of the sub band will be muted during RX or TX of the main band.

1. Press  key to enter function menu.
2. Turn the main band selector knob to choose No. 25 menu. The LCD displays "MUTE". 
3. Press the main band selector knob to enter function setup.
4. Switch the main band selector knob to choose desired value.

TX: When the main band is transmitting, the sub band will be muted.

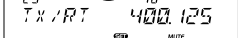



RX: When the main band is receiving, the sub band receiving will be muted.

RX/TX: the sub band receiving is always muted. 

5. Press the main band selector knob or  key to store value and return to function menu. Press  key or hold selector knob for one second to store setup and exit.

■ EDITING CHANNEL NAME

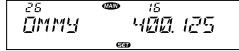
After editing a name for a channel, if the display mode is channel name, the LCD will display the name edited in this menu. Otherwise it will display the frequency.

1. Press  key to enter function menu. 
2. Switch the selector knob to choose No. 26 function menu. The LCD displays "NAME C".
3. Press the main band selector knob to enter function setup.
4. Switch the selector knob to choose desired character. 
5. Press the selector knob to confirm current character and to edit next character. After editing all seven characters, press the selector knob to confirm and return to function menu.
6. If the editing does not reach seven characters, press  key to return to function menu, then press  key or hold selector knob for one second to store setup and exit.

■ CHANNEL FUNCTION AUTO STORAGE SETUP

This function stores current configuration for each channel. When this function is on, the temporary configuration for the current channel will be stored, even if the channel is changed or the radio is powered off. When this function is off, the temporary configuration will not be stored. The channel information will be restored to the last stored value after changing the channel or after the radio is powered off.

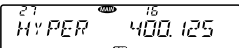
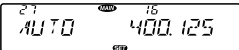
1. Press  to enter function menu 
2. Turn the main band selector knob to choose No. 27 menu, The LCD displays "HYPER".
3. Press the main band selector knob to enter function setup.
4. Switch the main band selector knob to choose desired value. 

MANUAL: Auto storage is turned off.

AUTO: Auto storage is turned on.

- Press the main band selector knob or **[SET]** key to store value and return to function menu. Press **[SQL]** key or hold selector knob for 1 second to store setup and exit.

■ MICROPHONE PA, PB, PC, PD KEY SETUP

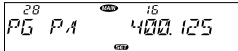
- Press **[SET]** key to enter function menu.
- Turn the main band selector knob to choose No. 28-31 menu. The LCD displays "PG PA" **PG PB, PG PC, PG PD**. 
- Press the main band selector knob to enter function setup.
- Switch the main band selector knob to choose desired value.
- Press the main band selector knob or **[SET]** key to store value and **[SQL]** return to function menu. Press key or hold selector knob for one second to store setup and exit.

 For Menu details, please refer to Page 31-32, Microphone Operation.

■ RF SQUELCH LEVEL SETUP

When squelch level function is on, you can cancel squelch only when the signal strength reaches the level setup by users.

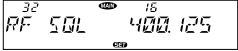
- Press **[SET]** key to enter function menu.
- Turn the main band selector knob to choose No. 32 menu. The LCD displays "RF SQL". 
- Press the main band selector knob to enter function setup.
- Switch the main band selector knob to choose desired value.

S-2: Able to hear a signal when the level meter reaches 1 bar.

S-5: Able to hear a signal when the level meter reaches 4 bars.

S-9: Able to hear a signal when the level meter reaches 8 bars.

S-FULL: Able to hear a signal when the level meter reaches full bars.

- Press the main band selector knob or **[SET]** key to store value and return to function menu. Press **[SQL]** key or hold selector knob for one second to store setup and exit. 

■ REPEATER OFFSET DIRECTION SETUP

- Press **[SET]** key to enter function menu.
- Turn the main band selector knob to choose No. 33 menu. The LCD displays "RPT MOD" 
- Press the main band selector knob to enter function setup.
- Switch the main band selector knob to choose desired offset direction.
-: Minus offset, transmitting frequency is lower than receiving frequency.
+: Plus offset, transmitting frequency is higher than receiving frequency.

OFF: OFFSET is turned off. Transmitting frequency is same as receiving frequency.

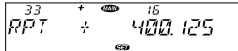
- Press the main band selector knob or **[SET]** key to store value and return to function menu. Press **[SQL]** key or hold selector knob for 1 second to store setup and exit. 

■ SCAN DWELL TIME SETUP

- Press **[SET]** key to enter function menu.
- Turn the main band selector knob to choose No. 34 menu. The LCD displays "SCAN". 
- Press the main band selector knob to enter function setup.

4. Switch the Main band selector knob to choose desired value.

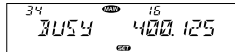

TIME: it pauses five seconds after detecting a matching signal, then resumes scan.

BUSY: it pauses after scanning a matching signal, then resumes scan after the signal disappears for 2 seconds.

SECEDE: It Stops after scanning a matching signal, and exits scan.

5. Press the Main band selector knob or **[SET]** key to store value and return to function menu. Press **[SQL]** key or hold selector knob for one second to store setup and exit.

PRIORITY CHANNEL SCAN

1. Press **[SET]** key to enter function menu.

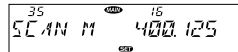

2. Turn the main band selector knob to choose No. 35 menu. The LCD displays "SCAN M".
3. Press the main band selector knob to enter function setup.
4. Switch the main band selector knob to choose desired value.

MEN: Channel Scan; the transceiver will scan all the channels.



MSN: Priority Channel Scanning; the transceiver will only scan the priority channel.

5. Press the main band selector knob or **[SET]** key to store value and return to function menu. Press **[SQL]** key or hold selector knob for one second to store setup and exit.

OFFSET FREQUENCY SETUP

- Press **[SET]** key to enter function menu.
- Turn the main band selector knob to choose No. 36 menu. The LCD displays "SHIFT".
- Press the main band selector knob to enter function setup.
- Switch the main band selector knob to choose desired value.
Available offset frequency for this transceiver is **0-100 MHz**.
- Press the main band selector knob or **[SET]** key to store value and return to function menu. Press **[SQL]** key or hold selector knob for 1 second to store setup and exit.



DISPLAY MODE SETUP

- Press **[SET]** key to enter function menu.
- Turn the main band selector knob to choose No. 37 menu. The LCD displays "DISPLAY".
- Press the main band selector knob to enter function setup.
- Switch the main band selector knob to choose desired value.

FREQ: The radio displays channel number + frequency in channel mode.



Press **[V/M]** key to change to VFO mode.

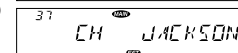

CH: Displays only channel number.

NAME: In channel mode, it displays the channel number and channel name if the current channel is programmed with a name. Otherwise, it display the channel number and frequency. Press **[V/M]** key to change to VFO mode.

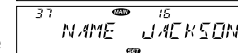

- Press the main band selector knob or **[SET]** key to store value and return to function menu. Press **[SQL]** key or hold selector knob for 1 second to store setup and exit.



Before using the priority channel scan function, the edited channel must be programmed as "P SCAN".

BUSY CHANNEL LOCKOUT

With this function on, the transceiver will not transmit on a busy channel, to avoid disturbing other transceivers using same frequency. If the channel is busy and you press PTT, the transceiver will beep as warning and return to receiving.

1. Press **[SET]** key to enter function menu.
2. Turn the main band selector knob to choose No. 38 menu. The LCD displays "RELOCK".
3. Press the main band selector knob to enter function setup.
4. Switch the main band selector knob to choose desired value.

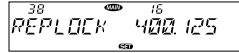

RLORP: Signaling busy lockout; transmitting is inhibited when current channel receives a matching carrier but non-matching CTCSS/DCS.

RLOBU: Channel busy lockout; transmitting is inhibited when current channel receives a matching carrier;

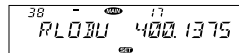
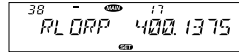

OFF: Busy channel lockout is disabled.

Transmitting is allowed in any receiving status.

5. Press the main band selector knob or **[SET]** key to store value and return to function menu. Press **[SQL]** key or hold selector knob for onesecond to store setup and exit.

RADIO'S DTMF SELF ID ENQUIRY

1. Press **[SET]** key to enter function menu.
2. Switch the selector knob to choose No. 39 function. The LCD displays "DTMF ID".
3. Press the main band selector knob to enter function setup. The LCD will show the DTMF self ID.
4. Press the main band selector knob or **[SET]** key to store value and return to function menu. Press **[SQL]** key or hold selector knob for one second to store setup and exit.

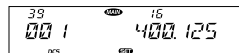
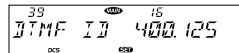
**5 TONE SELF ID ENQUIRY**

1. Press **[SET]** key to enter function menu.
2. Switch the selector knob to choose No. 40 function. The LCD displays "5TON ID".
3. Press the main band selector knob to enter function setup. The LCD will show the DTMF self ID.
4. Press the main band selector knob or **[SET]** key to store value and return to function menu. Press **[SQL]** key or hold selector knob for 1 second to store setup and exit.

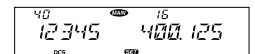
**TOT (TIME-OUT TIMER)**

The time-out timer limits the amount of continuous transmitting time.

When transmitting reaches the time limit that has been programmed, the transmission will be cut off and will emit a warning beep.

1. Press **[SET]** key to enter function menu.
2. Turn the main band selector knob to choose No. 41 menu. The LCD displays "TOT".
3. Press the main band selector knob to enter function setup.
4. Switch the main band selector knob to choose desired value.
1-30 MIN, total 30 levels.
OFF: TOT is disabled.
5. Press the main band selector knob or **[SET]** key to store value and return to function menu. Press **[SQL]** key or hold selector knob for 1 second to store setup and exit.

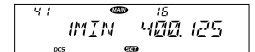
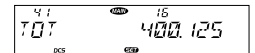

VFO FREQUENCY LINKAGE

Enable this function to adjust VFO frequency, will bring same frequency simultaneously for both bands. Adjust one knob, and the frequency for both bands will increase or decrease one step size value.

1. Press **[SET]** key to enter function menu.
2. Turn the Main band selector knob to choose No. 42 menu. The LCD displays "VFOTR".
3. Press the main band selector knob to enter function setup.
4. Switch the main band selector knob to choose desired value.
Available values: **ON**, **OFF**.
5. Press the main band selector knob or **[SET]** key to store value and return to function menu. Press **[SQL]** key or hold selector knob for one second to store setup and exit.

42 VFOTR 400.125

42 ON 400.125

NOTE This function is only valid when both bands are on VFO mode.

WIDE/NARROW BAND

1. Press **[SET]** key to enter function menu.
2. Turn the main band selector knob to choose No. 43 menu. The LCD displays "WIDNAR".
3. Press the main band selector knob to enter function setup.
4. Switch the main band selector knob to choose desired value.
WIDE: Wide band (25 kHz)
MIDDLE: Middle band (20 kHz)
NARROW: Narrow band (12.5 kHz)
5. Press the main band selector knob or **[SET]** key to store value and return to function menu. Press **[SQL]** key or hold selector knob for one second to store setup and exit. Refer to Wide/Narrow table in appendix.

43 WIDNAR 400.125

43 WIDE 400.125

43 MIDDLE 400.125

43 NARROW 400.125

CROSS BAND REPEAT

Set the left band and right band as VHF (136-174 MHz) and UHF (400-470 MHz), then turn on this function to enable Cross Band Repeat. **CAUTION: DO NOT EXCEED MID2 (10 WATT) POWER LEVEL, AS THIS WILL VOID YOUR WARRANTY.**

1. Press **[SET]** key to enter function menu.
2. Switch the selector knob to choose No. 44 function. The LCD displays "X-RPT".
3. Press the main band selector knob. The LCD displays "XSTART".
4. Press the main band selector knob, the radio beeps and the LCD displays "RPT". The cross band repeat function is on.

44 X-RPT 400.125

44 XSTART 400.125

NOTE Press **[SET]** to turn off cross band function.

LCD BACKLIGHT

1. Press **[SET]** key to enter function menu.
2. Turn the main band selector knob to choose No. 45-47 menu. The LCD displays "COL RED", "COL GRN", "COL BLU".
3. Press the main band selector knob to enter function setup.
4. Switch the main band selector knob to choose desired value. Each color (red, green, blue) has 32 brightness levels.
5. Press the main band selector knob or **[SET]** key to store value and return to function menu. Press **[SQL]** key or hold selector knob for one second to store setup and exit.

45 COL RED 400.125

46 COL GRN 400.125

47 COL BLU 400.125

47 BLU 2 400.125

MICROPHONE KEYPAD BACKLIGHT BRIGHTNESS

1. Press **[SET]** key to enter function menu.
2. Turn the main band selector knob to choose No. 48 menu. The LCD displays "DIMMER".
3. Press the main band selector knob to enter function setup.
4. Switch the main band selector knob to choose desired value from 32 brightness levels.
5. Press the main band selector knob or **[SET]** key to store value and return to function menu. Press **[SQL]** key or hold selector knob for one second to store.

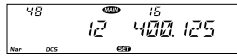
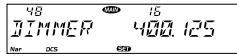
**CALLING RECORD**

The transceiver offers enquiry of calling record.

1. Press **[SET]** key to enter function menu.
2. Turn the main band selector knob to choose No. 49 menu. The LCD displays "NOTE".
3. Press the main band selector knob to enter function setup.
4. Switch the main band selector knob to choose desired value.



This transceiver is able to record 16 calls at most.

5. Press the main band selector knob or **[SET]** key to store value and return to function menu. Press **[SQL]** key or hold selector knob for one second to store setup and exit.

**AM FUNCTION**

1. Press **[SET]** key to enter function menu.
2. Turn the main band selector knob to choose No. 50 menu. The LCD displays "AM".
3. Press the main band selector knob to enter function setup.
4. Switch the main band selector knob to

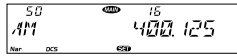

choose desired value.

ON: turn on AM function.

OFF: turn off AM function.

5. Press the main band selector knob or **[SET]** key to store value and return to function menu. Press **[SQL]** key or hold selector knob for one second to store setup and exit.



This function is only valid when the main band frequency is VHF 108-180 MHz on the left band. Right band will not receive AM.

AUTOMATIC AM FUNCTION

The radio will automatically receive AM mode when the VHF frequency is under 136 MHz

1. Press **[SET]** key to enter function menu.
2. Turn the main band selector knob to choose No. 51 menu. The LCD displays "AUT AM".
3. Press the main band selector knob to enter function setup.
4. Switch the main band selector knob to choose desired value.

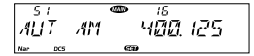

ON: turn on auto AM function.

OFF: turn off auto AM function.

5. Press the main band selector knob or **[SET]** key to store value and back to function menu. Press **[SQL]** key or hold selector knob for one second to store setup and exit.



To enable automatic AM function, the AM function must be turned on first.

EXTERNAL SPEAKER PORT

The radio has two external speaker options.

1. Press **[SET]** key to enter function menu.
2. Turn the main band selector knob to choose No. 52 menu. The LCD displays "VSPCONT".
3. Press the main band selector knob to enter function setup.
4. Switch the main band selector knob to choose desired value.

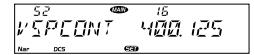

INT: Internal speaker, VHF and UHF band share internal speaker.
 Plug external speaker into the SP jack on rear of radio to hear both bands on external speaker.

EXT: Plug the optional Y speaker cable into the ST jack on rear of radio along with two speakers to split VHF and UHF audio.

- Press the main band selector knob or **[SET]** key to store value and return to function menu. Press **[SQL]** key or hold selector knob for over one second to store setup and exit.

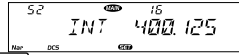

BEEP VOLUME CONTROL

- Press **[SET]** key to enter function menu.
- Turn the main band selector knob to choose No. 53 menu. The LCD displays **"BP-VOL"**.

- Press the main band selector knob to enter function setup

- Switch the main band selector knob to choose desired value.

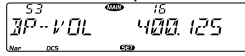

LOW: Beep volume is low.

HIGH: Beep volume is high.

- Press the main band selector knob or **[SET]** key to store value and return to function menu.

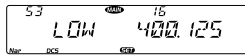

TALK AROUND

With this function on, the transceiver will transmit on the repeater output frequency when current channel is programmed with a repeater offset.

- Press **[SET]** key to enter function menu.
- Turn the main band selector knob to No. 54 menu. The LCD displays **"TALK"**.

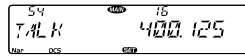

- Press the main band selector knob to enter function setup.
- Switch the main band selector knob to choose desired value
ON: Turn on Talk Around **OFF:** Turn off Talk Around

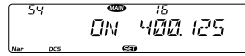

- Press the main band selector knob or **[SET]** key to store value and return to function menu. Press **[SQL]** key or hold selector knob for 1 second to store setup and exit.

MICROPHONE SPEAKER

- Press **[SET]** key to enter function menu.
- Turn the main band selector knob to choose No. 55 menu. The LCD displays **"HND SPK"**
- Press the main band selector knob to enter function setup.
- Switch the main band selector knob to choose desired value
HSPKOFF: Turn off microphone speaker.
HSPK ON: Turn on microphone speaker.
MSPKOFF: Turn off main speaker.

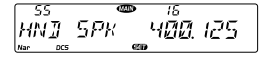

- Press the main band selector knob or **[SET]** key to store value and return to function menu. Press **[SQL]** key or hold selector knob for over 1 second to store setup and exit.

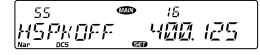

PASSWORD FUNCTION

- Press **[SET]** key to enter function menu.
- Turn the main band selector knob to choose No. 68 menu. The LCD displays **"PASSWD"**.
- Press the main band selector knob to enter function setup.
- Switch the main band selector knob to choose desired value.
ON: Turn on password function. **OFF:** Turn off password function.
- Press the main band selector knob or **[SET]** key to store value and return to function menu. Press **[SQL]** key or hold selector knob for 1 second to store setup and exit.



When password function is on, you will be required to enter it after power on. The password must be programmed before using this function.

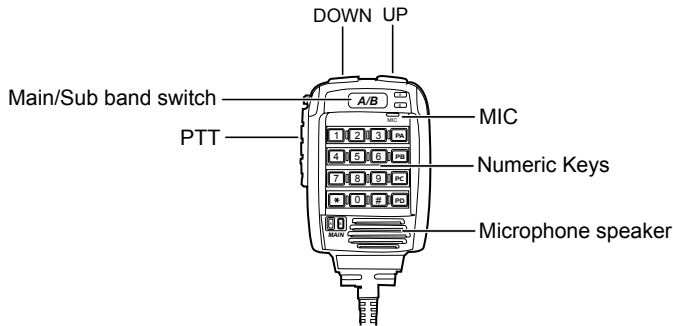

You can operate the transceiver by keypad or input desired frequency and channel through the microphone.

31

SEND DTMF SIGNALING

Hold the PTT key; input the desired DTMF signaling by the numeric keys.

MAIN/SUB BAND SWITCHING

This transceiver is defaulted on dual receive, in this status, a MAIN icon will display in the top right corner of the main band frequency; transmitting is only available on the main band. In standby, you can switch main band and sub band by the A/B key.

FUNCTION OPERATION THROUGH PA-PD KEYS

The PA,PB,PC,PD, keys are programmable with the following functions. See page 25 for microphone programming.

RPTR: OFFSET direction setup. In standby, press the key programmed as RPTR function to change the offset direction. When LCD displays "+", means TX offset id plus; when the LCD displays "-", means TX offset is minus.

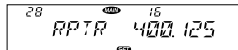

This function is valid only when current channel is set with offset frequency.

PRI: Add or delete priority channel. In channel mode, press the key programmed as **PRI** function to set priority channel. When the LCD displays ◀ the current channel is set as priority channel. Repeat above operation; the ◀ disappears, and the current channel is not set as priority channel.

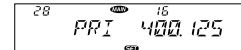

LOW: Output power setup. In standby, press the key programmed as **LOW** function to change the power level. When LCD displays HIGH, the transmitting power on current channel is high. When LCD displays MID1, the transmitting power on current channel is middle 1, When LCD displays MID2, the transmitting power on current channel is middle 2. When LCD displays LOW, the transmitting power on current channel is low.

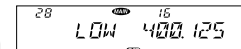

TONE: CTCSS/DCS code setup. In standby, press the key programmed as TONE function to setup CTCSS/DCS code. When the LCD displays "ENC" and CTCSS frequency, press the [**UP/DOWN**] key to choose CTCSS encode. When the LCD displays "ENC", "DEC" and CTCSS frequency, press the microphone [**UP/DOWN**] key to choose CTCSS decode. When the LCD displays "DCS" and DCS code, press the microphone [**UP/DOWN**] key to choose DCS code.

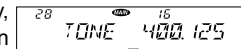

MHZ: In VFO mode, press the key programmed as MHz function; the megabit digital in the LCD flashes. Now turn the channel knob or microphone [**UP/DOWN**] key to adjust frequency by 1 MHz step. In channel mode, press this key; the channel number flashes. Adjust selector knob or microphone

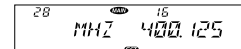

[**UP/DOWN**] key to adjust channel.

REV: In standby, press the key programmed as "**REV**" function to turn-on or turn off Frequency Reverse function.

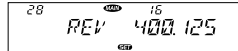

HOME: HOME channel switch. In standby, press the key programmed as "**HOME**" function to switch between home channel and current channel.

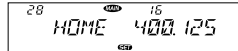

MAIN: Main band switch. In standby, press the key programmed as "**MAIN**" function to choose left band or right band as main band.

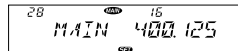

VFO/MR: Working mode switch. In standby, press the key programmed as "**VFO/MR**" function to switch between channel mode and frequency mode.

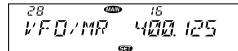

SCAN: Scan function. In standby, press the key programmed as "**SCAN**" function to start channel scan or frequency scan.

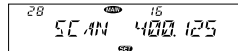

SQL OFF: Turn off squelch. In standby, press the key programmed as "**SQL OFF**" function to turn off squelch to hear very weak signals. Repeat the above function to turn on squelch.

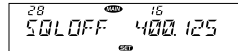

TBST: Transmit tone burst. In standby, press the key programmed as "**TBST**" function to transmit selected tone burst. This function is used to access some repeaters.

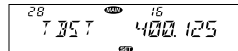

CALL OUT: Calling. In standby, press the key programmed as "**CALL OUT**" function to transmit pre-programmed DTMF, 2-Tone, or 5-Tone code.

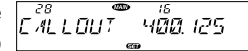

COMP: Compander function. In standby, press the key programmed as "**COMP**" to turn on or turn off compander function.

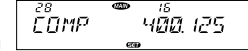

SCR: Scrambler function. In standby, press the key programmed as "**SCR**" function to turn on or turn off scrambler function. Choose optional scrambler groups (from nine fixed groups and two self defined groups).

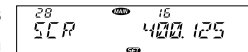

TONE DEC: Add optional signaling. In standby press the key programmed as "**TONE DEC**" function to choose DTMF(DT), 2-Tone (2T), 5-Tone (5T), or OFF.

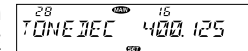

W/N: Wide or narrow band setup. In standby, press the key programmed as "**W/N**" function to choose wide band, middle band and narrow band.

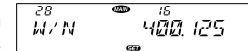

TALK: Transceiver transmits on repeater output. Press the key programmed as "**TALK**" to turn on or turn off talk-around function.



OFF: No function.

10 memory banks are available for memory channel assignments to ease in operation of the DB-750X dual band radio. You can enable one bank or multiple banks through either software programming or through the radio itself.

■ ASSIGNING A CHANNEL TO A MEMORY BANK

1. Select memory channel to assign to a memory bank.
2. Press **[SET]** key to enter function menu.
3. Turn the main band selector knob to choose No. 56 menu. The LCD displays "**BAK**".
4. Press the main band selector knob to enter function setup.
5. Switch the main band selector knob to choose desired value.

OFF: No bank assignment

A, B, C, D, E, F, G, H, I, J to assign the selected bank.

- 33 6. Press the main band selector knob or **[SET]** key to store.

■ CHOOSING ACTIVE BANK

1. Select either left or right band in memory mode.
2. Press **[SQL]** key to enter bank mode.
3. Bank numbers show in the position of channel number. If a channel number is not assigned, a bank "--" will show; otherwise the assigned bank of that channel will show.
4. Rotate the selector knob to choose desired bank to view.
5. Press **[SQL]** key to confirm. Radio will switch to chosen bank. You can now view or scan channels in chosen bank.
6. Press **[SQL]** key two times to cancel bank view and return to memory view.

■ BANK LINKING

Memory banks can be linked together for expanded scanning or viewing.

1. Press **[SET]** key to enter function menu.
2. Turn the main band selector knob to choose No. 57 menu. The LCD displays "**BALK**".
3. Press the main band selector knob to enter function setup.
4. Switch the main band selector knob to choose which banks to link. The following menus allow you to link banks A-J.

ON/OFF: Select ON to turn on Bank Linking, OFF to turn off Bank Linking

Menu 58	Bank A Link	ON /OFF
Menu 59	Bank B Link	ON /OFF
Menu 60	Bank C Link	ON /OFF
Menu 61	Bank D Link	ON /OFF
Menu 62	Bank E Link	ON /OFF
Menu 63	Bank F Link	ON /OFF
Menu 64	Bank G Link	ON /OFF
Menu 65	Bank H Link	ON /OFF
Menu 66	Bank I Link	ON /OFF
Menu 67	Bank J Link	ON /OFF

5. Press the main band selector knob or **[SET]** key to store.

This feature will copy the programmed data and parameters from the master unit to slave units. It copies the parameters and memory program settings.

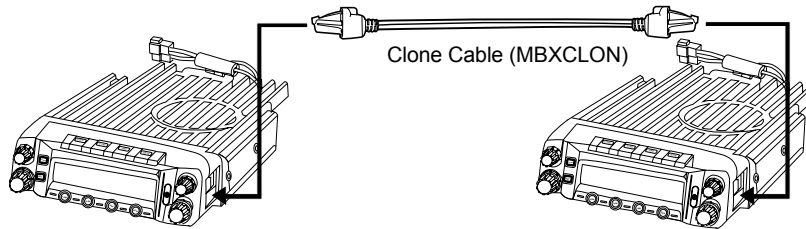

1. Use optional MBXCLON cloning cable; connect the cable between the data jacks on both master and slave.
2. Power on slave unit.
3. On master unit hold top **[LOW]** key while powering on and hold this key until LCD displays "**CLONE**".
4. On master unit turn left volume key down to 0.
5. On master unit hold **[SQL]** key till beep is heard, release, then short press **[SQL]** key to activate cloning.
6. While cloning, both master and slave units will display "**CLONE XX**" where "XX" stands for amount of data being cloned.
7. When master unit displays "**CLONE**" again and the slave unit repowers on, cloning is complete.

 **NOTE** To clone multiple radios, switch the slave unit with another radio by connecting the clone cable in the data jack. Turn the new slave radio on and then repeat step 5 above. If the data is not successfully transmitted, turn off both units. Make sure the cable connection is correct and repeat the entire operation from the beginning.

FACTORY RESET

If your radio seems to be malfunctioning because of wrong operation or setup, this function will be able to resume all setup and channels to factory default.

Hold the top **[SCV]** button while powering on the radio. All channel and function setups will resume to factory default. All memory channels will be erased.

DEFAULT VALUE FOR FACTORY RESUME

	Dual Band Mobile Radio	
	Left band	Right band
VFO frequency	145.150 MHz	435.150 MHz
Memory channel 1-758		
Offset direction	--	--
Offset frequency	600 kHz	5 MHz
Step size	10 kHz	
CTCSS code	--	
CTCSS frequency	88.5 Hz	
DCS code	--	
DCS group	017N	
Output power	HI	
Key lockout	OFF	
TOT	3	
APO	OFF	
Squelch level	4	

TROUBLE SHOOTING

Problem	Possible Causes and Potential Solutions
(a) Power is on, nothing appears on display.	+ and - polarities of power connection are reversed. Connect red lead to plus terminal and black lead to minus terminal of DC power supply.
(b) Fuse is blown.	Check and solve problem resulting in blown fuse and replace fuse with new fuse.
(c) Display is too dim.	Adjust the dimmer to higher level.
(d) No sound comes from speaker.	<ul style="list-style-type: none"> • Squelch is muted. Decrease squelch level. • Tone or CTCSS/DCS squelch is active. Turn CTCSS or DCS squelch off.
(e) Key and dial do not function.	Key-lock function is activated. Cancel key-lock function.
(f) Rotating dial will not change memory channel.	Transceiver is in CALL mode or VFO mode.
(g) PTT key is pressed but transmission does not occur.	<ul style="list-style-type: none"> • Microphone connection is poor. Connect microphone properly. • Antenna connection is poor. Connect antenna properly.

General

Frequency range	RX: 108-136 MHz AM 136-174 MHz FM Wide/FM Narrow 220-260 MHz FM Wide 350-490 MHz FM Wide/FM Narrow
	TX: 136-143.995 MHz FM Narrow 144-147.995 MHz FM Wide 148.000-174 MHz FM Narrow 400-429.995 MHz FM Narrow 430-449.995 MHz FM Wide 450-469.995 MHz FM Narrow 470-490 MHz FM Wide
Number of channels	750 channels
Channel spacing	25 kHz(Wide band)
	20 kHz(Middle band)
	12.5 kHz (Narrow band)
Phase-locked step	2.5 kHz, 5 kHz, 6.25 kHz, 10 kHz, 12.5 kHz, 15 kHz, 20 kHz, 25 kHz, 30 kHz, 50 kHz
Operating voltage	13.8 V DC \pm 15%
Squelch	Carrier/CTCSS/DCS/5-Tone/2-Tone/DTMF
Frequency stability	\pm 2.5 ppm
Operating temperature	-20 ~ +60°C
Dimensions(WxHxD)	139 (W) x 40 (H) x 212 (D) mm
Weight	about 1.14 kg

RX/TX: 144-146 MHz, 430-440 MHz

Receiver (ETSI EN 301 783)

	Wide band	Narrow band
Sensitivity (12dB SINAD)	\leq 0.25 μ V	\leq 0.35 μ V
Adjacent channel selectivity	\geq 70 dB	\geq 60 dB
Audio response	+1~-3 dB (0.3-3 kHz)	+1~-3 dB (0.3-2.55 kHz)
Hum & Noise	\geq 45 dB	\geq 40 dB
Audio distortion	\leq 5%	
Audio power output	>2 W @ 10%	

Transmitter (ETSI EN 301 783)

	Wide band	Narrow band
Power output	50 W / 25 W / 10 W / 5 W (VHF) 40 W / 25 W / 10 W / 5 W (UHF)	
Modulation	16K Φ F3E	11K Φ F3E
Adjacent channel power	\geq 70 dB	\geq 60 dB
Hum & Noise	\geq 40 dB	\geq 36 dB
Spurious emission	\geq 70 dB	\geq 70 dB
Audio response	+1~-3dB (0.3-3 kHz)	+1~-3dB (0.3-2.55 kHz)
Audio distortion	\leq 5%	

■ 51 GROUPS CTCSS TONE FREQUENCY(HZ)

62.5	77.0	91.5	107.2	127.3	151.4	167.9	183.5	199.5	225.7	254.1	
67.0	79.7	94.8	110.9	131.8	156.7	171.3	186.2	203.5	229.1	Self Defined	
69.3	82.5	97.4	114.8	136.5	159.8	173.8	189.9	206.5	233.6		
71.9	85.4	100.0	118.8	141.3	162.2	177.3	192.8	210.7	241.8		
74.4	88.5	103.5	123.0	146.2	165.5	179.9	196.6	218.1	250.3		

The self defined CTCSS tone supports non-standard codes. The frequency must be pre-programmed

■ 1024 GROUPS DCS CODE

000	001	002	003	004	005	006	007
010	011	012	013	014	015	016	017
020	021	022	023	024	025	026	027
030	031	032	033	034	035	036	037
040	041	042	043	044	045	046	047
050	051	052	053	054	055	056	057
060	061	062	063	064	065	066	067
070	071	072	073	074	075	076	077
100	101	102	103	104	105	106	107
110	111	112	113	114	115	116	117
120	121	122	123	124	125	126	127
130	131	132	133	134	135	136	137
140	141	142	143	144	145	146	147
150	151	152	153	154	155	156	157
160	161	162	163	164	165	166	167
170	171	172	173	174	175	176	177
200	201	202	203	204	205	206	207
210	211	212	213	214	215	216	217
220	221	222	223	224	225	226	227
230	231	232	233	234	235	236	237
240	241	242	243	244	245	246	247
250	251	252	253	254	255	256	257
260	261	262	263	264	265	266	267
270	271	272	273	274	275	276	277
300	301	302	303	304	305	306	307
310	311	312	313	314	315	316	317
320	321	322	323	324	325	326	327
330	331	332	333	334	335	336	337

340	341	342	343	344	345	346	347
350	351	352	353	354	355	356	357
360	361	362	363	364	365	366	367
370	371	372	373	374	375	376	377
400	401	402	403	404	405	406	407
410	411	412	413	414	415	416	417
420	421	422	423	424	425	426	427
430	431	432	433	434	435	436	437
440	441	442	443	444	445	446	447
450	451	452	453	454	455	456	457
460	461	462	463	464	465	466	467
470	471	472	473	474	475	476	477
500	501	502	503	504	505	506	507
510	511	512	513	514	515	516	517
520	521	522	523	524	525	526	527
530	531	532	533	534	535	536	537
540	541	542	543	544	545	546	547
550	551	552	553	554	555	556	557
560	561	562	563	564	565	566	567
570	571	572	573	574	575	576	577
600	601	602	603	604	605	606	607
610	611	612	613	614	615	616	617
620	621	622	623	624	625	626	627
630	631	632	633	634	635	636	637
640	641	642	643	644	645	646	347
650	651	652	653	654	655	656	657
660	661	662	663	664	665	666	667
670	671	672	673	674	675	676	677
700	701	702	703	704	705	706	707
710	711	712	713	714	715	716	717

720	721	722	723	724	725	726	727
730	731	732	733	734	735	736	737
740	741	742	743	744	745	746	747
750	751	752	753	754	755	756	757
760	761	762	763	764	765	766	767
770	771	772	773	774	775	776	777

Menu	Name	Default	Page	Function	Settings
1	APO	OFF	16	APO (AUTOMATIC POWER OFF)	Settings from 0.5 through 12 hours, OFF
2	ARS	OFF	16	AUTOMATIC OFFSET	OFF; when ON, offset for 136-174 MHz is 0.6 MHz; 400-490 MHz is 5 MHz
3	STEP	2.5	16	FREQUENCY CHANNEL STEP SETUP (in Hz)	2.5 k, 5 k, 6.25 k, 10 k, 12.5 k, 15 k, 20 k, 25 k, 30 k, 50 k
4	BAND	ON	17	VFO BAND LOCKOUT	ON, OFF
5	BEEP	ON	17	BEEP FUNCTION	ON, OFF
6	CLKSFT	OFF	17	CPU CLOCK FREQUENCY CHANGE	ON, OFF
7	2TN ENC	00	17	2TONE ENCODE SELECT	0-23
8	5TN ENC	00	18	5TONE ENCODE SELECT	0-99
9	TON DEC	OFF	18	ADD OPTIONAL SIGNALING	DT(DTMF), 2T, 5T, OFF
10	TC CDCS	OFF	18	CTCSS ENCODE SETUP	62.5-254.1 / 000N -7771
11	RX CDCS	OFF	19	CTCSS DECODE SETUP	OFF, CTCSS, DCS
12	DSP SUB	FREQ	19	SUB BAND DISPLAY SETUP	FREQ, DC-IN, OFF
13	DTMF D	500ms	19	DTMF ENCODE PRE-LOADING TIME	100 ms, 300 ms, 500 ms, 800 ms, 1000 ms
14	DTMF S	50ms	20	DTMF ENCODE TRANSMITTING TIME	30 ms, 50 ms, 80 ms, 100 ms, 150 ms, 200 ms, 250 ms
15	DTMF W	--	20	DTMF ENCODE SETUP	06-16 (6 codes)
16	SGN SQL	SQ	20	SQUELCH MODE SETUP	SQ,CTSS/DCS,TONE,CT*TO,CT/TO
17	COMP	OFF	21	COMPANDER	ON, OFF – Reduces background noise
18	SCR	OFF	21	SCRAMBLER SETUP	1-9,U1,U2, OFF
19	TBST	1750	21	TONE BURST	100 Hz, 1450 Hz, 1750 MHz, 2100 Hz
20	KEYMOD	KEY 1	22	KEYPAD MODE SETUP	Upper and Lower buttons configuration. KEY1, KEY2
21	LOCK	OFF	23	KEYPAD LOCKOUT	ON, OFF
22	LOCKT	OFF	23	TX OFF (PTT LOCKOUT)	BANDR,BANDL,BAND BOTH, OFF
23	SQL	04	23	SQUELCH LEVEL SETUP	1 – 20 levels
24	REV	OFF	23	FREQUENCY REVERSE	ON / OFF
25	MUTE	TX	24	SUB BAND MUTE SETUP	TX, RX, RX/TX
26	NAME C	-----	24	EDITING CHANNEL NAME	7 CHARACTERS
27	HPER	AUTO	24	CHANNEL FUNCTION AUTO STORAGE SETUP	MANUAL/AUTO - HYPER
28	PG PA	VFO/MR	25	MICROPHONE PA	MULTIFUNCTION KEY PRESS DEFINITION
29	PG PB	TALK	25	MICROPHONE PB	MULTIFUNCTION KEY PRESS DEFINITION
30	PG PC	SCAN	25	MICROPHONE PC	MULTIFUNCTION KEY PRESS DEFINITION
31	PG PD	OFF	25	MICROPHONE PD	MULTIFUNCTION KEY PRESS DEFINITION
32	RF SQL	OFF	25	RF SQUELCH LEVEL SETUP	S2, S5, S9, S-full
33	RPT MOD	OFF	25	OFFSET DIRECTION SETUP	-, +, OFF
34	SCAN	TIME	25	SCAN DWELL TIME SETUP	TIME, BUSY, SECEDE

Menu	Name	Default	Page	Function	Settings
35	SCAN M	MEM	26	PRIORITY CHANNEL SCAN	MEN, MSN
36	SHIFT	600	26	OFFSET FREQUENCY SETUP	0 – 100 MHz
37	DISPLAY	FREQ	26	DISPLAY MODE SETUP	FREQ, CH, NAME
38	REPLOCK	OFF	27	BUSY CHANNEL LOCKOUT	RLORP, RLOBU, OFF
39	DTMF ID	001	27	RADIO'S DTMF SELF ID ENQUIRY	
40	5TON ID	12345	27	5STONE SELF ID ENQUIRY	
41	TOT	2 MIN	27	TOT (TIME-OUT TIMER)	1-30 MIN
42	VFOTR	OFF	28	VFO FREQUENCY LINKAGE	ON, OFF
43	WIDNAR	NARROW	28	WIDE/NARROW BAND	WIDE (25 kHz), MIDDLE (20 kHz), NARROW (12.5 kHz)
44	X-RPT	--	28	CROSS BAND REPEAT	X-RPT, XSTART
45	LDC RED	1	28	LCD BACKLIGHT	RED
46	LCD GRN	32	28	LCD BACKLIGHT	GRN
47	LCD BLU	32	28	LCD BACKLIGHT	BLU
48	DIMMER	32	29	KEYPAD BACKLIGHT BRIGHTNESS - MICROPHONE	BRIGHTNESS – 32 LEVELS
49	NOTE	--	29	CALLING RECORD	RECORD THE LAST 16 CALLS
50	AM	ON	29	AM FUNCTION	ON, OFF
51	AUT AM	AUTO	29	AUTOMATIC AM FUNCTION	ON, OFF
52	VSPCONT	IN	29	VHF EXTERNAL SPEAKER PORT	INT, EXT SP1, SP2
53	BP-VOL	LOW	30	BEEP VOLUME CONTROL	LOW, HIGH
54	TALK	OFF	30	TALK AROUND	
55	HND SPK	MSPKOFF	30	MICROPHONE SPEAKER	HSPKOFF, HSPKON, MSPKOFF
56	BAK	OFF	33	MAIN BANK SET (BANKS – SET LEFT / RIGHT SIDE)	OFF, A, B, C, D, E, F, G, H, I, J
57	BALK	OFF	33	BANK LINKING	ON/OFF
58	BLK A	OFF*	33	ENABLE LINK TO THE MAIN BANK SET	ON/OFF (*Menu 58–67 will not appear until menus 56 & 57 are activated)
59	BLK B	OFF*	33	ENABLE LINK TO THE MAIN BANK SET	ON/OFF
60	BLK C	OFF*	33	ENABLE LINK TO THE MAIN BANK SET	ON/OFF
61	BLK D	OFF*	33	ENABLE LINK TO THE MAIN BANK SET	ON/OFF
62	BLK E	OFF*	33	ENABLE LINK TO THE MAIN BANK SET	ON/OFF
63	BLK F	OFF*	33	ENABLE LINK TO THE MAIN BANK SET	ON/OFF
64	BLK G	OFF*	33	ENABLE LINK TO THE MAIN BANK SET	ON/OFF
65	BLK H	OFF*	33	ENABLE LINK TO THE MAIN BANK SET	ON/OFF
66	BLK I	OFF*	33	ENABLE LINK TO THE MAIN BANK SET	ON/OFF
67	BLK J	OFF*	33	ENABLE LINK TO THE MAIN BANK SET	ON/OFF
68	PASS	OFF	30	Enter a PASSWORD	



Powerwerx
263 N Berry St
Brea, CA 92821
www.powerwerx.com

FC CE 0700 ⓘ  

Rev D 8/2013